

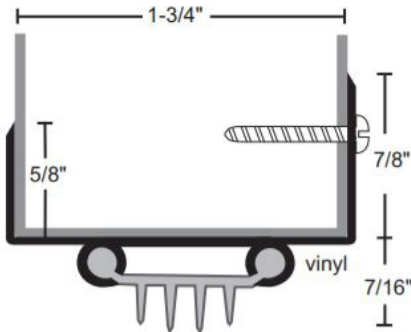

**TRADEMARK
HARDWARE**

WORLD OF QUALITY HARDWARE

Installation Guide



Installation Instructions

1. Measure and cut door shoe to fit.
2. Items with drip cap should be notched to clear stops on jambs before installation.
3. Position seal on door with gasket compressed $1/16$ " against sill.
4. Mark screw holes.
5. Drill pilot holes with a $7/64$ " bit.
6. Install with screws provided.
7. Adjust position so that gasket does not impede proper closing and latching of door.

SKU: N26N



www.tmhardware.com



845-388-1300



845-388-1388



sales@tmhardware.com